

TFB

Quick Release

The True Forming Back, or TFB, has been created to provide extreme comfort, unparalleled customization options and trouble-free adjustability. The hardware is durable, easily accessible, and is hidden with a hook-and-loop attached back for a clean, sleek look.

Item	ID	Part Number	Description	Qty.
A. Mount				
	A1	TFB200-66	T-Nut, True Forming Back	2
	A2	TFB200-53	L-Bracket	1
	A3	1/4 SSW	1/4" Stainless Steel Washer	2
	A4	1/4-20 x 5/8 BHS	1/4-20 x 5/8" Button Head Screw	2
B. Latch Assembly				
	B1	1/4-20 LNN	1/4-20 Nylon Lock Nut	2
	B2 ¹	8-32 x 3/16 BHS	8-32 x 3/16" Button Head Cap Screw	2
	B3 ¹	8 x 3/4 FW	8 x 0.75" Fender Metal Washer	2
	B4 ¹	1/4 x .28 x .74 x .06 FW	1/4" Flat Plastic Washer	2
	B5 ¹	BR5012	Removable Boomerang	1
	B6 ¹	BR5013	Lock Piece	1
	B7 ¹	8-32 x 1/4 x 5/16 FTS	8-32 x 1/4" x 5/16" Female Threaded Standoff	1
	B8	1/4 SSW	1/4" Stainless Steel Washer	2
	B9	1/4-20 x 5/8 BHS	1/4-20 x 5/8" Button Head Cap Screw	2
C. Back-Post Clamp				
	C1	10-32 x 1/2 BHS	1/4-20 x 1 1/4" Button Head Screw	4
	C2	BR5008-1	10-32 x 1/2" Button Head Screw	2
	C3	1/4x1 10-32 TRS	1/4" x 1" 10-32 TRS	2
	C4	BR5034	Backing Pin	1
	C5	BR5003	Quick Release Seatback - Inside Clamp	1
	C6	BR5002	Quick Release Seatback - Outside Clamp	1
	C7	M5 F2	M5 Flat Washer	2
	C8 ²	M5 x 0.8 x 25mm SHS	M5 x 0.8 x 25mm Socket Head Cap Screw	2

¹ Note: Items B2-B7 are pre-assembled as a single piece ² M5 X 0.8 X 22mm SHS (2) included for 3/4" and 7/8" installations.

Installation and Use

The Quick Release hardware includes features such as angle, width, and depth adjustments.

Angle Adjustment

- Allows approximately 20° of adjustment
- There is no loss of seat depth with angle adjustment

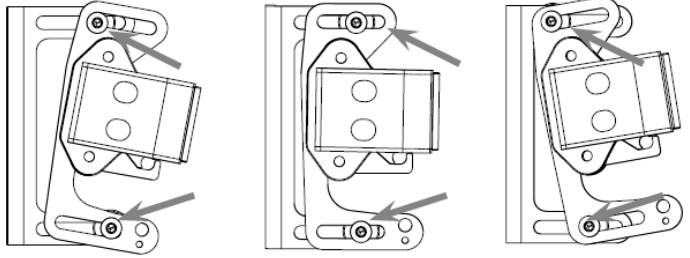

Width Adjustment

- Approximately 1 inch (2.54cm) of width adjustment.
- By loosening the screws (A4) on the mount, the hardware can be adjusted horizontally to increase the space between the two quick release assemblies.

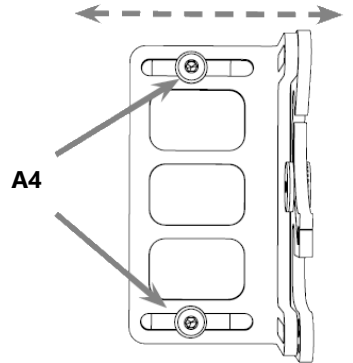

Depth Adjustment

- Approximately 1.25 inches (3.18 cm) of depth adjustment available.
- Center mounting of hardware positions the back cushion valley behind the back posts.
- Forward mounting of hardware positions the back cushion forward 5/8 in.
- Aft mounting of the hardware positions the back cushion rearward 5/8 in.

B1/B9

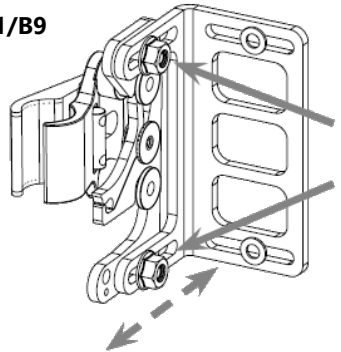

Cane Compatibility

- The Quick Release hardware mounts to multiple diameter cane clamps without the use of spacers.
- Hardware is compatible with 1 in., 3/4 in., and 7/8 in. cane diameters.

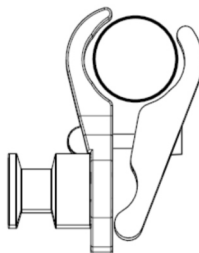

1" Clamp

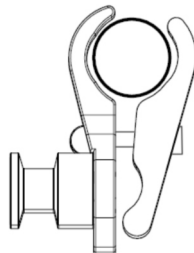

7/8" Clamp

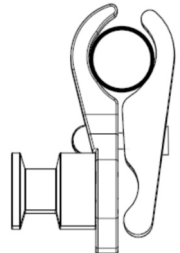

3/4" Clamp

NOTE: The 25mm SHS is intended ONLY for 1" cane. Use the included 22mm SHS for 3/4" and 7/8" installations.

Mounting Hardware to the Back

STEP 1

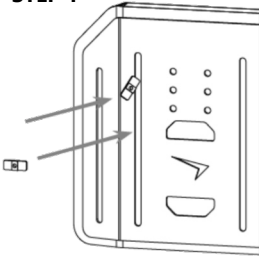

STEP 2

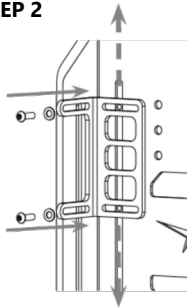

Step One:

Take one of the T-Nuts (A1) and place it in the slot on the front side (user side) of the aluminum shell.

Step Two:

Line up the L-Bracket (A2), on the rear of the aluminum shell, with the T-Nut (A1) and ensure it is in the appropriate horizontal and vertical position. Secure it with a 1/4-20 x 5/8" button head screw (A4) and a 1/4" washers (A3). Tighten the screw to hold the bracket in place. Repeat for the second T-Nut on this bracket.

STEP 3

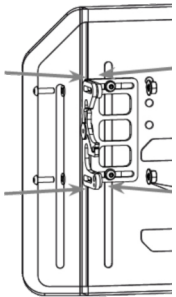

STEP 4

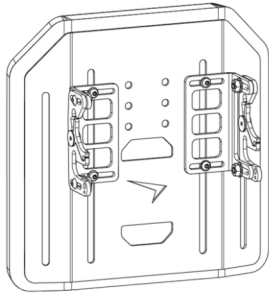

Step Three:

Position the latch assembly (B) on the L-Bracket (A2) and attach it with two 1/4-20 x 5/8" button head screws (B9) with 1/4" washers (B8) on one side and a 1/4-20 lock nut (B1) on the other. Make sure the assembly is positioned at the correct depth and angle needed prior to tightening the screws.

Step Four:

Repeat Steps 1 through 3 to install the second hardware assembly.

Clamp Assembly to Wheelchair Back Post

Step One:

Visually determine the desired height of the TFB. Mark on each back post the needed location to attach the clamp assemblies.

Step Two:

Loosen the 1/4-20 x 7/16" socket head cap screws (C8) and with two fingers, pinch and hold the back of the post clamp open. Slide the clamp assembly over the top of the back post (receiving post facing inward). (Screws do not have to be completely removed from hardware to slide clamp over the post.)

Step Three:

Slightly tighten each screw (C8*). Align clamp assembly parallel to the wheelchair seat base.

Step Four:

To achieve proper alignment, slightly move the mounting hardware in or out and/or up and down. Make adjustments until the backrest smoothly attaches and removes from the top and bottom receiving posts.

Step Five:

After final adjustments are complete, tighten all screws (C8*). This will ensure secure placement and safe operation.

STEP 1



STEP 2

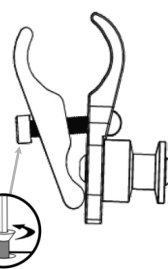

STEP 3

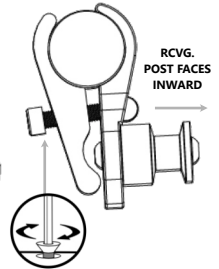

STEP 4

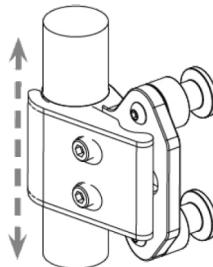

STEP 5

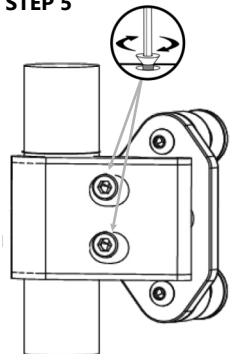

* NOTE: The 25mm SHS is intended ONLY for 1" cane. Use the included 22mm SHS for 3/4" and 7/8" installations.

Important

These products are designed to be fitted, applied, and installed exclusively by a health care professional trained for these purposes. The fitting, application and installation by a non-qualified individual could result in serious injury. **Stealth Products, LLC** accepts no liability for personal injury or damage that may arise from the failure of the user or other persons to follow the recommendations, warnings, and instructions in this manual. **Stealth Products** does not hold responsibility for final integration of final assembly of product to end user. **Stealth Products** is not liable for user death or injury. Initial setup and driving should be done in an open area free of obstacles until the user is fully capable of driving safely.

Before you begin using this product, it is important that you read and understand the content of these installation and operating instructions. Product misuse due to failure to adhere to instructions and warnings in this document will void your warranty and may result in property damage, injury or death. Always keep the operating instructions in a safe place so they may be referenced as necessary. If this document contains information you do not understand or if there are concerns about safety or operation, contact your provider.

All information, pictures, illustrations and specifications are based on the product information available at the time of printing, and are representative examples. They are not intended to be exact descriptions of the various parts of the product. Instructions are written with the expressed intent of use with standard configurations. They also contain important safety and maintenance information. For assistance with advanced configurations or options, contact your provider or **Stealth Products** at (512) 715-9995 or toll free at (800) 965-9229.

Immediately discontinue use if any function is compromised, if parts are missing or loose or if any component shows signs of excessive wear. Consult with your provider for repair, adjustment or replacement. You can download additional copies of this manual by visiting <https://stlpro.site/stealth-docs/> and searching for "Quick Release Hardware" in the document manager.

Warranty

Our products are designed, manufactured, and produced to the highest of standards. If any defect in material or workmanship is found, **Stealth Products** will repair or replace the product at our discretion. Any implied warranty, including the implied warranties of merchantability and fitness for a particular purpose, shall not extend beyond the duration of this warranty. **Stealth Products, LLC** does not warrant damage due to, but not limited to, misuse, abuse, or misapplication of products and modification of product without written approval from **Stealth Products, LLC**. Any alteration or lack of serial number, where applicable, will automatically void this warranty. **Stealth Products, LLC** is liable for replacement parts only, and is not liable for any incurred labor costs. No person is authorized to alter, extend, or waive the warranties of **Stealth Products, LLC**.

Please visit <https://stlpro.site/returns-n-warranty> to learn more about our warranty and returns policy.

About Us

Stealth Products is committed to 100% customer satisfaction. Your complete satisfaction is important to us. Please contact us with suggestions or feedback to help us improve the quality and usability of our products.

You may reach us at:



Stealth Products, LLC

info@stealthproducts.com
www.stealthproducts.com
(800) 965-9229 | (512) 715-9995
104 John Kelly Drive, Burnet TX 78611

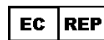

MDSS GmbH
Schiffgraben 41
30175 Hannover, Germany

