

Custom Seat Cushion Order Form

This order form requires the latest version of Acrobat Reader.

[E2609]

US Only. HCPCS codes provided should not be considered as legal advice and do not guarantee reimbursement.

Fields or sections with asterisk (*) are required

+1 (512) 715-9995
 +1 (800) 965-9229 Toll Free
 +1 (512) 715-9954 Fax
 +1 (800) 806-1225 Toll Free Fax
 104 John Kelly Drive,
 Burnet, TX 78611
 information@sw.stealthproducts.com
 www.stealthproducts.com
 facebook.com/StealthProducts
 twitter.com/stealthproducts

PO#:

Client:

Branch: **Date:**

Contact:

E-mail:

Phone: **Fax:**

Mark for: Type Quote Order

Mobility Base Information

Manufacturer:

Model Number:

Serial Number:

Frame Color:

Frame Width:

Frame Depth:

Tubing: 3/4in (1.91cm) 7/8in (2.22cm) 1in (2.54cm)

CLIENT SEAT AREA MEASUREMENTS

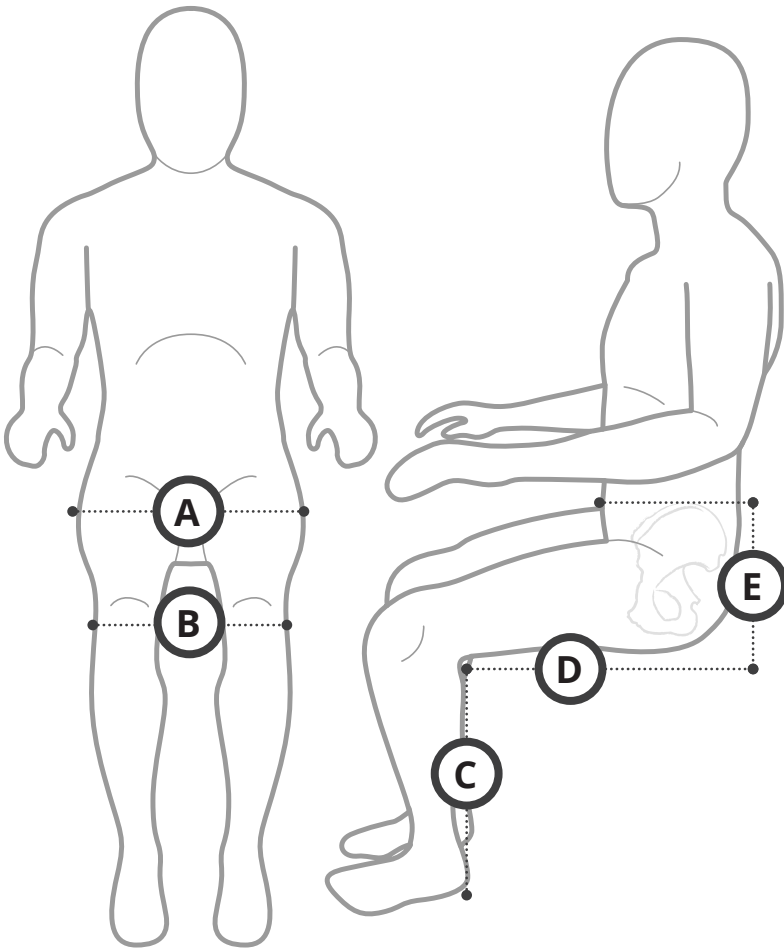

A. Seat Width:

B. Knee Adduction:

C. Seat to Footplate:

D. Total Seat Depth:

E. Seat to PSIS:

Seat Cushion Expected Overall Dimension

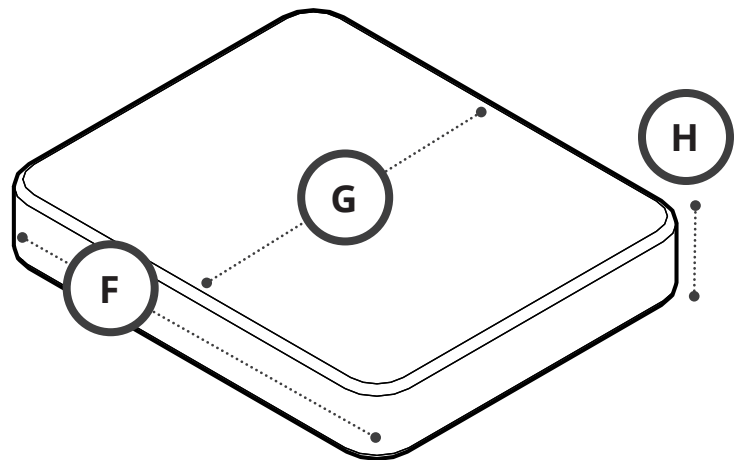

F. Overall Depth:

G. Overall Width:

H. Overall Height:

Internal Use Only

For CSRs use only. Summary of selections will show up here to confirm accuracy of configuration.

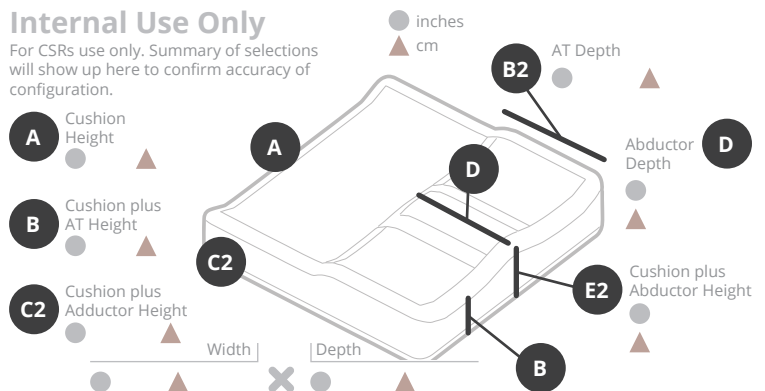

Estimated Custom Cushion MSRP Value

SS353/SS355

1 Cushion Size

ESTIMATED VALUE

Fields or sections with asterisk (*) are required

SEAT CUSHION SIZING*

	Width	10in (25.40cm)	12in (30.48cm)	14in (35.56cm)	16in (40.64cm)	18in (45.72cm)	20in (50.80cm)	\$590		
		22in (55.88cm)	24in (60.96cm)							
\$477	Depth	10in	<input type="checkbox"/> SMD1010	<input type="checkbox"/> SMD1210						
		12in	<input type="checkbox"/> SMD1012	<input type="checkbox"/> SMD1212	<input type="checkbox"/> SMD1412					
		14in	<input type="checkbox"/> SMD1014	<input type="checkbox"/> SMD1214	<input type="checkbox"/> SMD1414	<input type="checkbox"/> SMD1614				
		16in		<input type="checkbox"/> SMD1216	<input type="checkbox"/> SMD1416	<input type="checkbox"/> SMD1616	<input type="checkbox"/> SMD1816			
		18in			<input type="checkbox"/> SMD1418	<input type="checkbox"/> SMD1618	<input type="checkbox"/> SMD1818	<input type="checkbox"/> SMD2018		
		20in				<input type="checkbox"/> SMD1620	<input type="checkbox"/> SMD1820	<input type="checkbox"/> SMD2020	<input type="checkbox"/> SMD2220	
\$550		22in				<input type="checkbox"/> SMD1822	<input type="checkbox"/> SMD2022	<input type="checkbox"/> SMD2222	<input type="checkbox"/> SMD2422	
		24in					<input type="checkbox"/> SMD2024	<input type="checkbox"/> SMD2224	<input type="checkbox"/> SMD2424	

CLIENT SPECIFIED SIZING

The seat cushion will require extended lead time and a 60% upcharge if its sizing falls outside the above matrix. Set sizes by 1in (2.54cm) increments.

SMDCSHSPO Specified Dimensions Seat Base: W x D 60% surcharge

COVER CONTACT MATERIAL*

Coolcore® Air Mesh Stealth-Tek

Coolcore is a research proven performance fabric technology that adapts to its environment and regulates temperature by managing heat and moisture. The proprietary construction helps manage and distribute moisture quickly throughout the fabric to enhance the evaporation and drying time.

Air Flow Mesh, better known as **Air Mesh**, is equipped with fine pores for superior air circulation, it can assist with positioning if the client has sliding issues with the current cushion cover material. This fabric is ideal for those in hot or humid environments.

Stealth-Tek is a cast coated fabric, which are nylon/polyester fabric coated with polyurethane through the cast coating method. These type of fabrics are waterproof with stretch capability and applications in medical and health-care. Stealth-Tek is Fluid Proof PU Film laminated to 100% polyester knit T-jersey. It is used in a variety of applications. Waterproof, Breathable and Washable.

Add Polyurethane Liner (Incontinent Liner)
If I-Style Special Modification is selected there will be a \$120 upcharge for Incontinent Liner I-Style Modification.

Add Zipper Pouch \$25
SMDZPCOVMOD

SMDPUL **SMDIS-L \$120**
[For Part Number Reference](#)
[Download Addendum A.1](#)
I-Style Liner Modification

Need Help? Call +1 (512) 715-9995
Call toll free at +1 (800) 965-9229

Cushion Notes

2 Basic Cushion Shape

Fields or sections with asterisk (*) are required

ESTIMATED VALUE

2.1 Select Base Format*

SS353

Use increments of 1in (2.54cm)

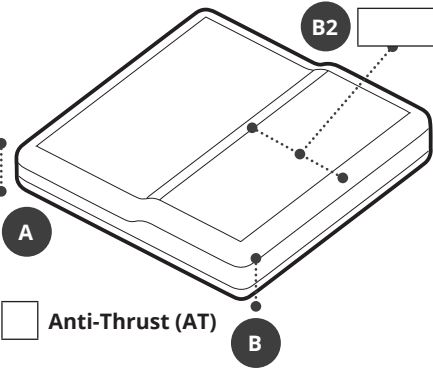

Anti-Thrust Depth

Anti-Thrust Height

- 1/2in (1.27cm)
- 1in (2.54cm)
- 1 1/2in (3.81cm)
- 2in (5.08cm)
- 2 1/2in (6.35cm)

OR

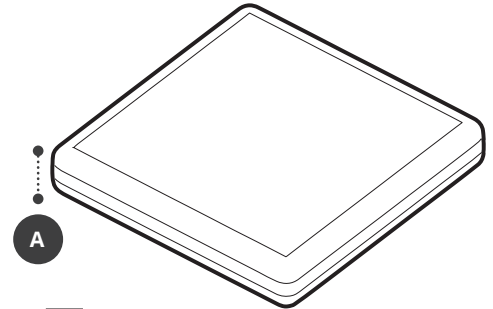

A. Cushion Back Height:

B. Cushion Front Height:

Apply only to Anti-Thrust. Will display total cushion front height expected from selection.

Omit Anti-Thrust (Planar)

OR

2.2 Select Contour Option

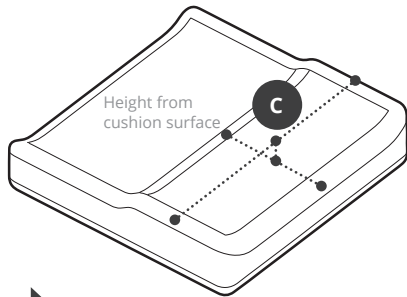

Anti-Thrust with Adductor

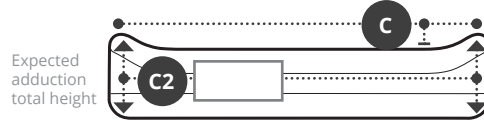

Adductor Specifications

C Adductor Height (from Surface)

- 1/2in (1.27cm)
- 1in (2.54cm)
- 1 1/2in (3.81cm)
- 2in (5.08cm)
- 2 1/2in (6.35cm)

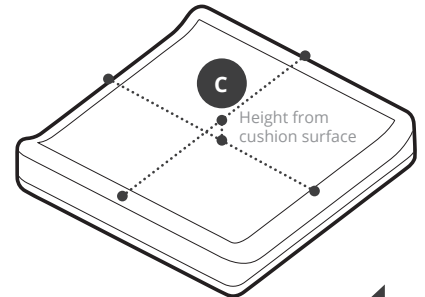

Planar with Adductor

OR

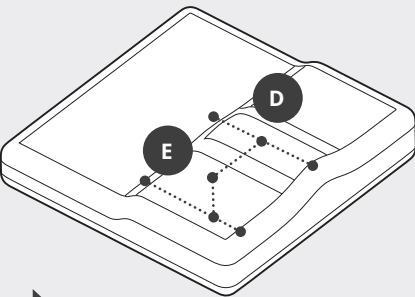

Anti-Thrust with Abductor

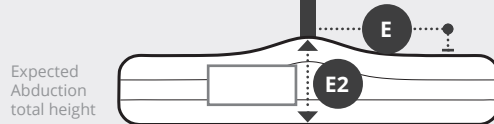

Abductor Specifications

D Abductor Depth

Set at 1in (2.54cm) increments

E Abductor Height (from Surface)

Increments of 1/2in (1.27cm)

- 1in (2.54cm)
- 1 1/2in (3.81cm)
- 2in (5.08cm)

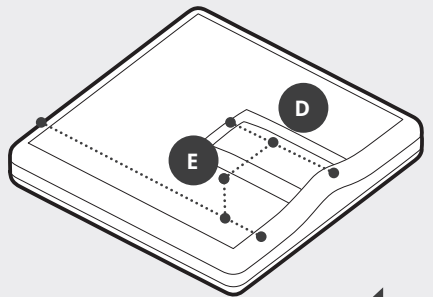

Planar with Abductor

SS355

Contoured Seat Cushion

Full contoured seat cushion requires field values highlighted on the illustration.

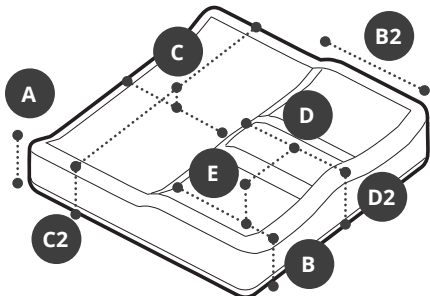

Full Contour with Anti-Thrust

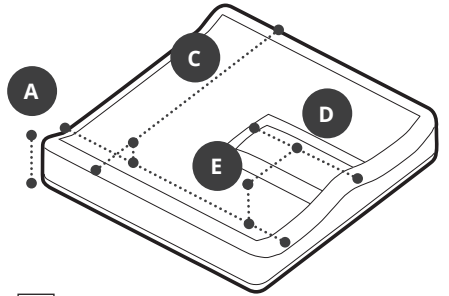

Planar Full Contour

Need Help? Call +1 (512) 715-9995
Call toll free at +1 (800) 965-9229

FOAM OPTIONS

- 5/8in (1.59cm) Cross Link Foundation Foam***
- 1in (2.54cm) OC3

Note: The cover included with the cushion supports up to 4.5in (11.43cm) of foam thickness, any thickness beyond that will require to contact directly an Stealth Representative or CSR and extended lead time.
***Contour Format requires Cross Link Foundation Foam.

3.1 BASE LAYER*

3.2 MIDDLE LAYER

Note: Base and Middle layers can have a total of 1 1/2in (3.81cm) maximum thickness of any available foam combination.

1/2in (1.27cm) SunMate® FRG **\$140.00 ea.**

- Soft SMDFO -L-SMFRG3-0.5
- Medium Soft SMDFO -L-SMFRG4-0.5
- Medium SMDFO -L-SMFRG5-0.5

1in (2.54cm) SunMate® FRG **\$140.00 ea.**

- Soft SMDFO -L-SMFRG3-1
- Medium Soft SMDFO -L-SMFRG4-1
- Medium SMDFO -L-SMFRG5-1

1/2in (1.27cm) Open Cell (OC) **\$0.00**

- Medium SMDFO -L-OC3-0.5

1in (2.54cm) Open Cell (OC) **\$0.00**

- Medium SMDFO -L-OC3-1

1/2in (1.27cm) SunMate® FRG **\$140.00 ea.**

- Extra Soft SMDFO -M-SMFRG2-0.5
- Soft SMDFO -M-SMFRG3-0.5
- Medium Soft SMDFO -M-SMFRG4-0.5

1in (2.54cm) SunMate® FRG **\$140.00 ea.**

- Extra Soft SMDFO -M-SMFRG2-1
- Soft SMDFO -M-SMFRG3-1
- Medium Soft SMDFO -M-SMFRG4-1

1/2in (1.27cm) Open Cell (OC) **\$0.00**

- Medium SMDFO -M-OC3-0.5

1in (2.54cm) Open Cell (OC) **\$0.00**

- Medium SMDFO -M-OC3-1

Total Foam Thickness

in
 cm

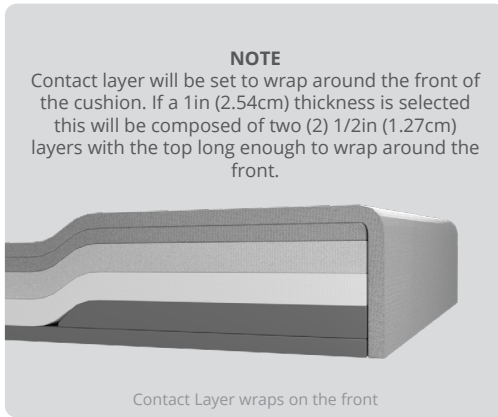

3.3 CONTACT LAYER

1/2in (1.27cm) SunMate® FRG **\$190.00 ea.**

- Extra Extra Soft SMDFO -U-SMFRG1-0.5
- Extra Soft SMDFO -U-SMFRG2-0.5
- Soft SMDFO -U-SMFRG3-0.5

1in (2.54cm) SunMate® FRG **\$190.00 ea.**

- Extra Extra Soft SMDFO -U-SMFRG1-1
- Extra Soft SMDFO -U-SMFRG2-1
- Soft SMDFO -U-SMFRG3-1

1/2in (1.27cm) Open Cell (OC) **\$0.00**

- Medium SMDFO -U-OC3-0.5

1in (2.54cm) Open Cell (OC) **\$0.00**

- Medium SMDFO -U-OC3-1

Cushion Dimensions Summary

For internal use only. Summary of selections will show up here to confirm accuracy of configuration.

Width X Depth in
 X cm

A Cushion Height in cm

B Cushion plus AT Height in cm

B2 AT Depth in cm

C2 Cushion plus Adductor Height in cm

D Cushion plus Abductor Height in cm

E2 Abductor Depth in cm



For part numbers reference download the addendum at StealthHub.StealthProducts.com or scan the QR code on the left.

4 Special Cut Outs

For Part Number Reference Download Addendum A.1

Special Cut-outs
Sub-Total

ESTIMATED
VALUE

LEG LENGTH DISCREPANCY

GROWTH ADAPTATIONS

RELIEFS

SMDLLD - **\$125**

Short Right (select depth below)

Short Left (select depth below)

1/2in (1.27cm) 1in (2.54cm) 1 1/2in (3.81cm) 2in (5.08cm)

\$235 **SMDIS**

I Style

\$30 **SMDGN** -

Growth Notch (Select Depth)

1in (2.54cm) 2in (5.08cm) 3in (7.62cm)

Seat Depth

45° Slope

Depth: 1in (2.54cm) 2in (5.08cm) **SMDHSR** -

Hamstring Relief **\$55**

SMDINS

Gel Insert select below

Ischial Relief (select gel type below)

Viscous Gel **\$60** Ultra-Lite Gel **\$115**

Good for End Users who have poor trunk control and need better immersion to stabilize the pelvis.

Good for end users who need more movement and less shear. Pediatric users for example.

5 Mounting

No Mounting

Seat Pan

SMDSP



Also available
ADI™
Carbon Fiber
Seat Pans
for weights
under 250 lb

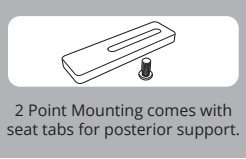

Rigidizer ACM
ABS Contour Mold

SMDRGD

Not compatible with the I-Style Cut Out and might not be compatible with some cushion widths or depths, see note below.

Small **\$135** **Medium** **\$140** **Large** **\$145**

16in Width (40.64cm) 18in Width (45.72cm) 20in Width (50.80cm)

Can be cut on designated ridges to the following sizes:

Small: 16in x 16in, 16in x 18in
Medium: 18in x 16in, 18in x 18in, 18in x 20in
Large: 20in x 18in, 20in x 20in

Rigidizer Flat ABS **Wedge Kit** **SMDRGD**

Flat rigidizer final dimensions will match cushion dimensions. For part number reference download Addendum A.1 at stealthhub.stealthproducts.com

Seat Pan Hardware **No Hardware**

Trouble Free **Knob** **J & L**

SMDHW **P-**

Mounting Format: **4 pt** **2 pt**

Optional: **Seat to Back**
TFB seat to back bracket

TFBMSDB
\$200.20

Order the bracket when 2 point mounting format is selected, and the current back system does not include one. Also, consider if the seating system expects no flexing by the posterior area.

NOTES



+1 (512) 715-9995
+1 (800) 965-9229 Toll Free
+1 (512) 715-9954 Fax
+1 (800) 806-1225 Toll Free Fax

104 John Kelly Drive,
Burnet, TX 78611
information@sw.stealthproducts.com
www.stealthproducts.com
[facebook.com/StealthProducts](https://www.facebook.com/StealthProducts)
twitter.com/stealthproducts